

sala 41 h=3,18-3,21m

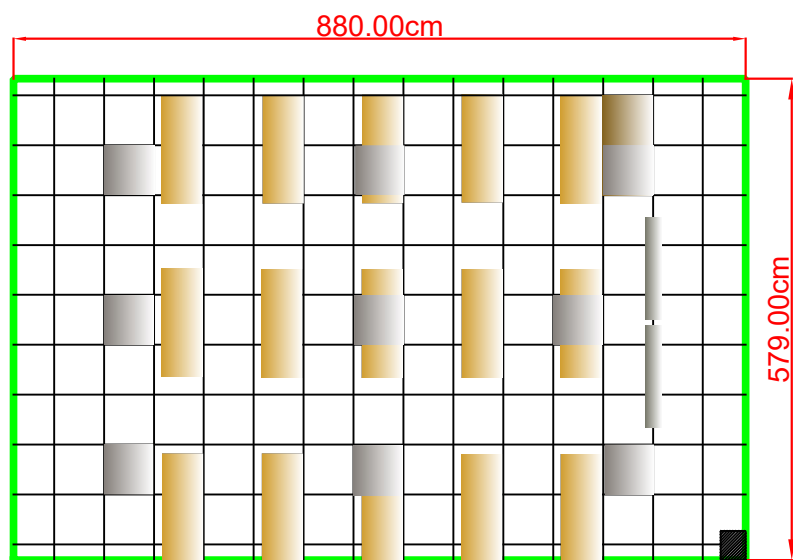

sala 42 h=3,18-3,20m

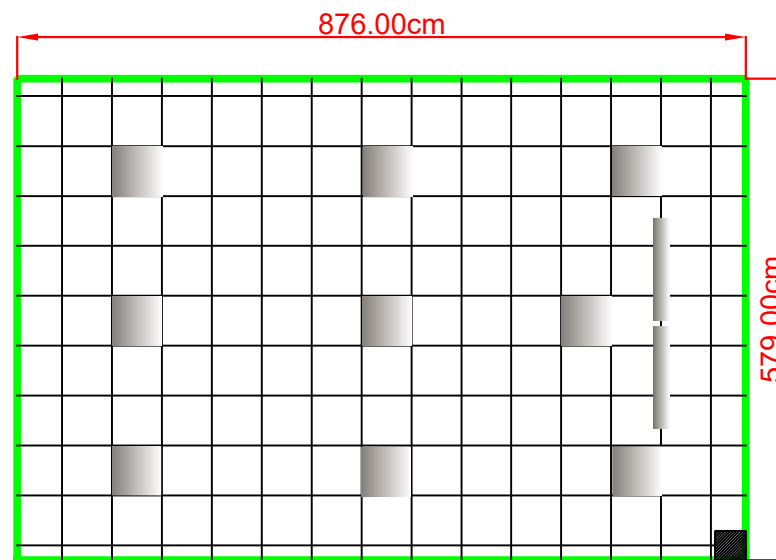

- oprawa 60x60cm do wbudowania Led
- oprawa asymetryczna Led
- ławka szkolna

sala 43 h=3,18-3,20m

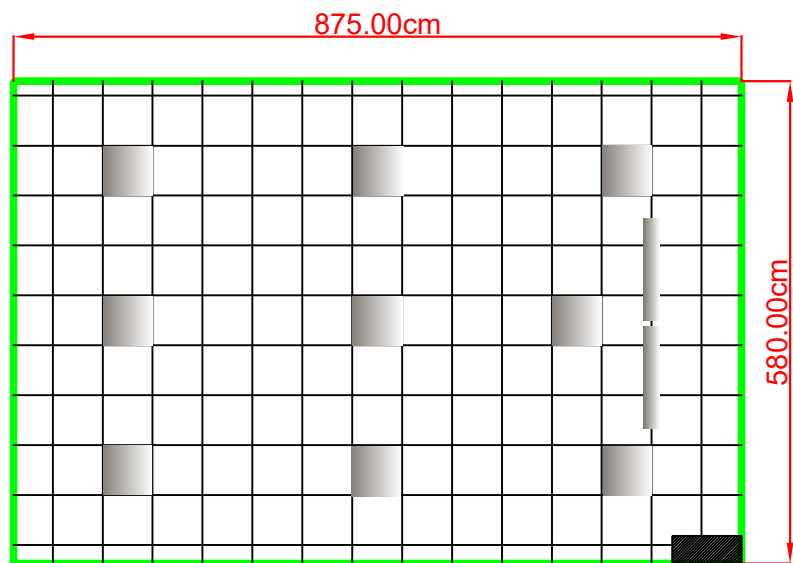

sala 44 h=3,18-3,21m

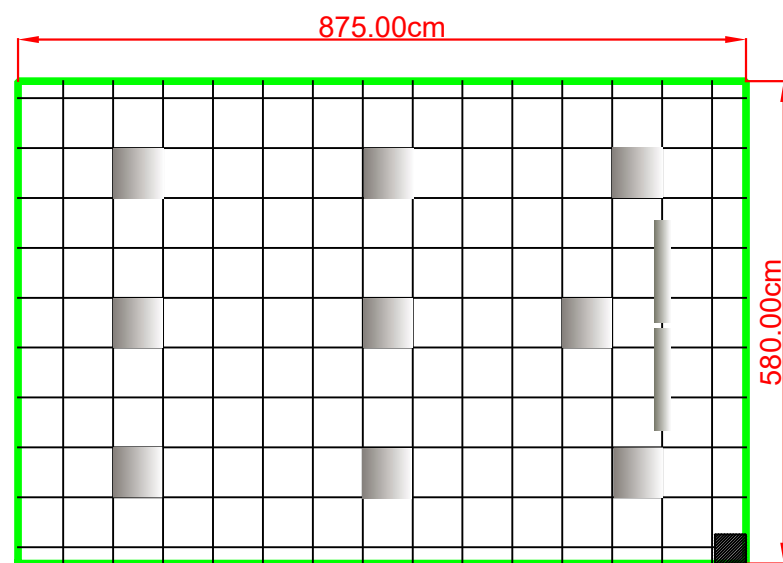

**Szkoła Podstawowa  
nr 8 w Policach  
Budynek A-2; Parter  
wysokość montażu sufitu  
podwieszanego - 3,05m**

sala 50 h=3,16-3,20m

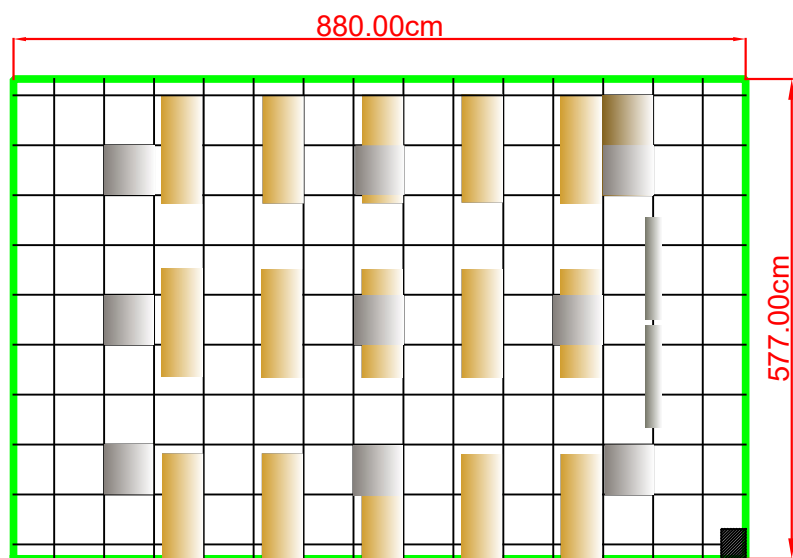

sala 51 h=3,17-3,21m

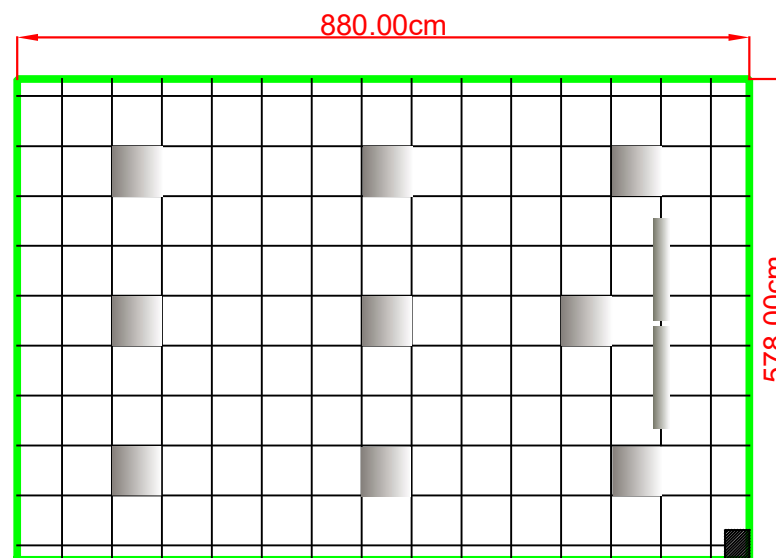

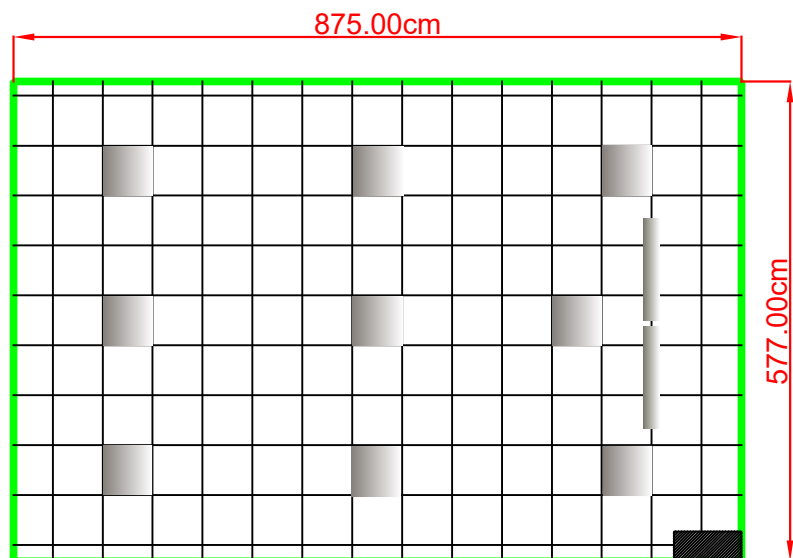

sala 52 h=3,17-3,22m

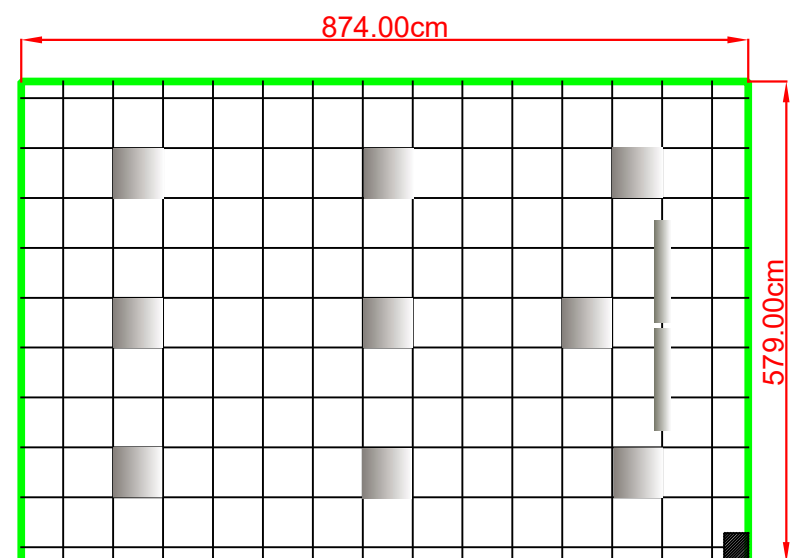

sala 53 h=3,17-3,22m



-  oprawa 60x60cm do wbudowania Led
-  oprawa asymetryczna Led
-  Ławka szkolna

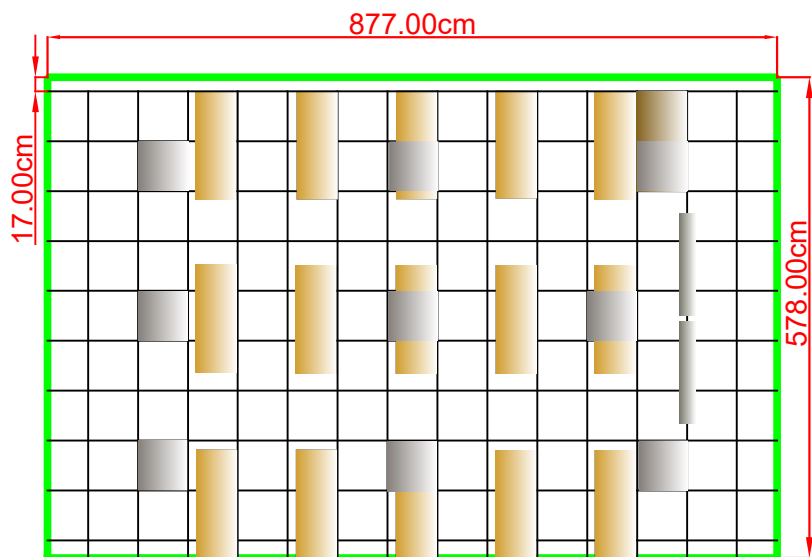

**Szkoła Podstawowa  
nr 8 w Policach  
Budynek A-2; Piętro I  
wysokość montażu sufitu  
podwieszanego - 3,05m**

sala 59 h=3,18-3,19m

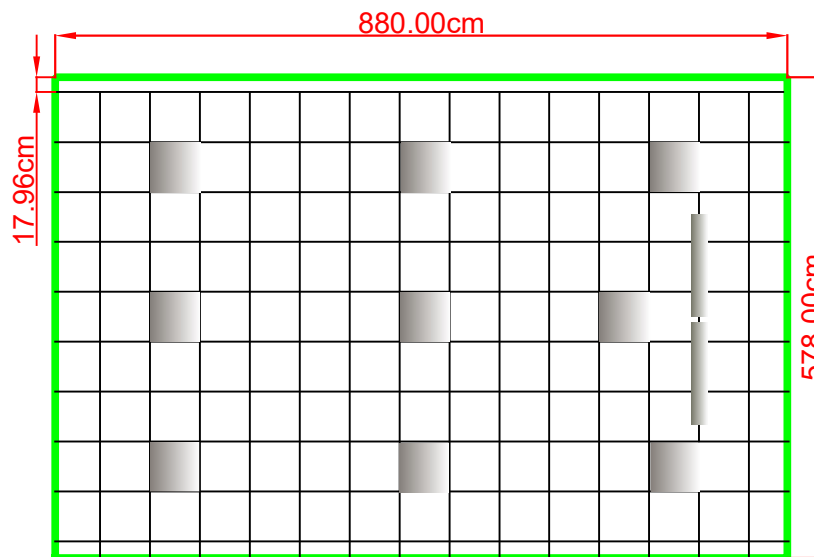

sala 60 h=3,18-3,21m



-  oprawa 60x60cm do wbudowania Led
-  oprawa asymetryczna Led
-  ławka szkolna

sala 61 h=3,18-3,20m

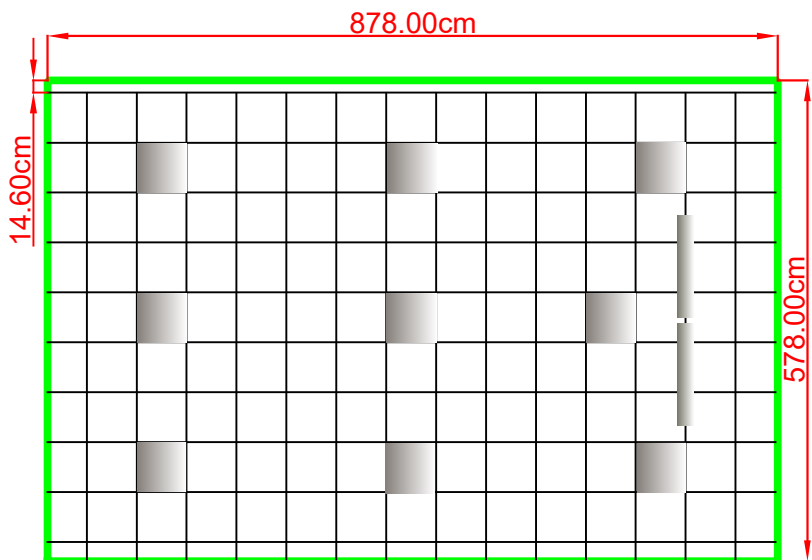

sala 62 h=3,18-3,19m

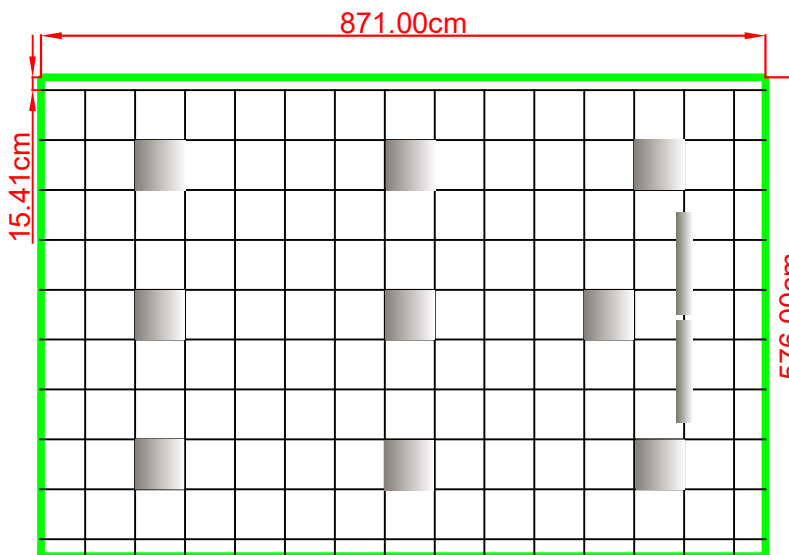

**Szkoła Podstawowa  
nr 8 w Policach  
Budynek A-2; Piętro II  
wysokość montażu sufitu  
podwieszanego - 3,05m**

## przekrój poprzeczny przez sale II piętra

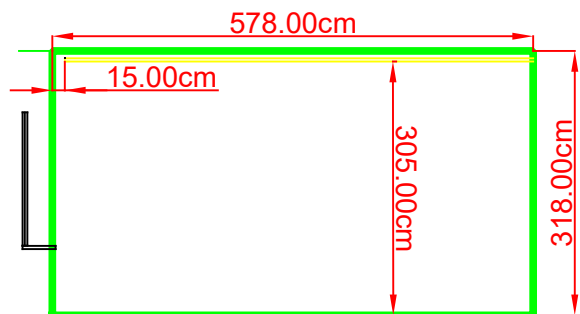

sala 57 h=3,18-3,23m

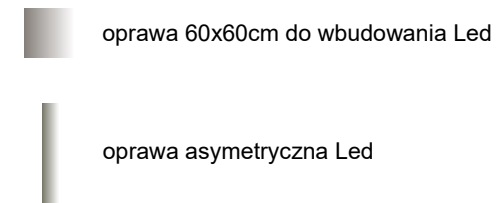
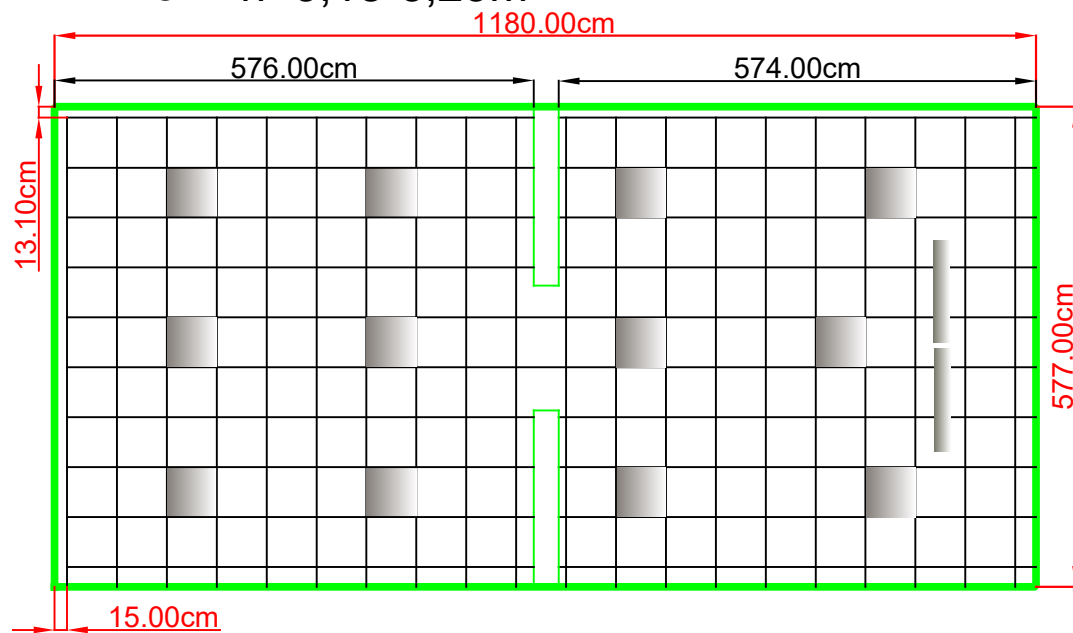

**Szkoła Podstawowa  
nr 8 w Policach  
Budynek A-2; Piętro II cz. 2  
wysokość montażu sufitu  
podwieszanego - 3,05m**